



Note: These kits are not legal for use on pollution controlled vehicles

Instruction Manual

for the following Go EFI System

37001 - Retro LS EFI System

Please read the full instructions before beginning your installation. These instructions cover the basic kit installation and setup. Failure to follow these instructions may result in malfunctioning of the

system. For technical assistance with your Retro LS Kit, call the FiTech EFI Tech Line at (951)340-2624

Warning: Caution must be observed when installing any product involving fuel system parts. Work in a well ventilated area with an **approved fire extinguisher readily available**. Eye protection and other safety apparel should be worn to protect against debris and sprayed gasoline. We recommend having this installation performed by an experienced, qualified, automotive technician. The finished installation must be thoroughly checked for any fuel system leaks. All safety precautions must be observed when working with fuel. Disconnect the battery ground wire (-) before starting the installation.



Retro LS Kit 37001 KIT CONTENTS

- (1) 4-injector throttle body with Classic Carburetor Gold finish.
- (4) inlet/outlet port plugs (Installed on throttle body)
- (1) Main Harness
- (1) ECU
- (1) 1/2" NPT to 3/8" NPT Reducer
- (4) Injectors pre-installed
- (1) Idle Air Control (Pre-Installed)
- (1) Throttle Position Sensor (Pre-Installed)
- (1) MAP Sensor (Pre-Installed)
- (1) Wide Band O₂ Sensor
- (1) Clamp on O₂ Bung Kit
- (1) Handheld Controller with billet case
- (1) Windshield Mount for Controller
- (1) -06 AN crossover hose with -6AN male inlet fitting (Pre-Installed)
- (1) Gasket kit

Figure 1

Table of Contents

Kit contents	1	MAP	4	IAC setup	6
About your Go EFI Retro LS Kit	2	IAC	4	Handheld Controller Initial	7
Special instructions	2	TPS	4	Programming	7
Engine protection feature Vacuum Ports	2,3	CTS	4	Fan Setup	7
Throttle Body Installation	3	Important Sensors	5	Wire Chart	8
Wide Band O ₂ Sensor Installation	3	Coolant Sensor Installation	6	Fuel Delivery Requirements	9
Air Leaks	4	Injectors	6	Fuel Delivery schematic	10
Installing the Harness	4	Wiring the EFI System	6		
		On-Engine Adjustments	6		

About your FiTech Go EFI Retro LS System

CONGRATULATIONS on your purchase of the FiTech EFI System! The Retro LS Kit will bolt directly to any 4-BBL Intake Manifold. To fit on a spread bore 4-BBL manifold requires an inexpensive adapter plate to avoid leaks. Suitable adapter plates are available from several suppliers such as Summit Racing. The Retro LS Kit is self-tuning once the initial setup is performed using the hand-held controller. When the necessary initial inputs are made with the hand-held controller the EFI System creates a base fuel map to get the engine running. Then the self-tuning programming will fine tune the map to produce optimum power and performance. Through the use of a Wide Band O₂

Sensor the system can continuously make adjustments in the fuel delivery to provide the correct air/fuel ratio under all climate and altitude conditions. Several sensors are also integrated in the throttle body assembly including the Throttle Position Sensor (TPS), and the Manifold Absolute Pressure Sensor (MAP). The Wide Band O₂ Sensor is installed into the exhaust pipe. This system is designed with safety in mind and has a self adjusting "limp home" mode. It also has a data logging feature to track what is going on with the system while it is running, to ensure optimal performance.

Special instructions

Make sure that you remove ALL low pressure hoses, fittings and clamps on factory fuel lines and replace them with EFI rated fuel hose. Also the use of proper flared connections and clamps is a necessity. Be careful not to mix 45° and 37° AN fittings, they look similar but will not work together. 45° fittings usually come from a hardware store or auto parts store while 37° AN fittings are the ones supplied by FiTech and most speed shops.

Cranking fuel and hard throttle hits (accelerator pump) are tuned by the user. Selecting the right "cam" and engine CID (Cubic Inch Displacement) during setup will get the learning closer. Cruise and wide open throttle (WOT), mixture (trims) are continuously learned and tweaked by the system.

- The Retro LS Kit needs an external fuel pressure regulator set at 58 PSI. A Force Fuel containing a high pressure pump and regulator is available (PN 50004). This serves as a fuel pressure amplifier and is fed by a low pressure mechanical/electric pump.

The Retro LS Kits are intended for use with unleaded pump gas. The system is compatible with E-85, but this requires advanced tuning knowledge. Maximum horsepower fueling capacity is reduced by approximately 30% with E-85. Fuel system components should be E-85 compatible and in new condition to prevent sludge from breaking loose.

The Retro LS Kit is designed to be used with all the LS based motors, it uses Cam and Crank sensors for optimum timing control.

- This system is NOT smog legal.
- The Retro LS Kit comes with preinstalled 80-lb flow matched injectors and is capable of handling up to 650 hp.
- The Retro LS Kit does all the timing control control like the Ultimate LS Kits

Always turn off ignition and allow at least 15 seconds for ECU to save if disconnecting battery

Very important note: Your fuel tank must have a vent to prevent pressure building up inside the tank.

Engine Protection Feature

The Retro LS Kit is programmed with a "limp home mode". This feature does not shut down your system, instead the ECU is designed to compensate if a sensor fails. This means, that if for any reason a sensor fails, that sensor will receive either a default value or a simulated value. This is to ensure that the engine remains running in a safe and controlled manner so that you can get to a repair facility, or to your home, to resolve the issue. Due to the compensation features of the ECU, the way to check if something is going wrong with your system, is by the fault

codes option on the main menu of your hand-held controller. The fault code comes up under OBD-II, diagnostic standard, but to the right of the code it will state which sensor is having the problem. A new feature programmed into the hand-held is a rev offset. This feature will protect the engine from long term abuse because it lowers your built in rev limiter enable to prevent over revving and possible engine damage during warm up. It will automatically turn the feature off once your engine reaches operating temperature.

Determining Use of Vacuum Ports

Determine the engine's need for vacuum ports including ported and manifold vacuum. These ports cover accessories such as power brakes, vacuum advance, transmission modulator, PCV and possibly more. There are two 3/16" male nipples and three 3/8" male nipples. See figure 1 and 2 for location and use of various vacuum nipples.

**Very Important Note:
Your fuel tank MUST be vented to
prevent pressure from building up
inside the tank.**

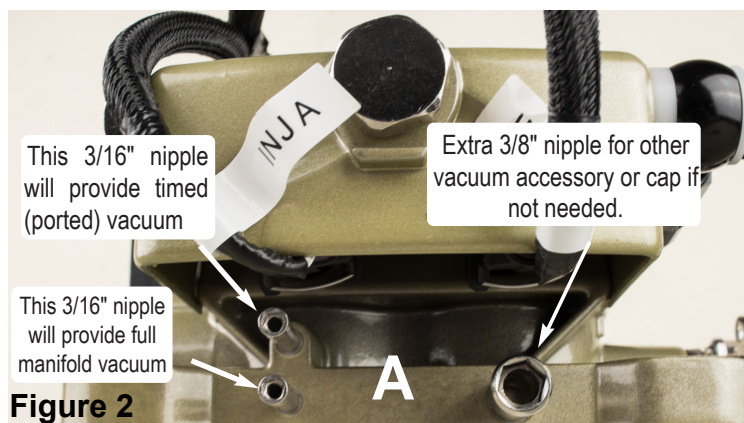
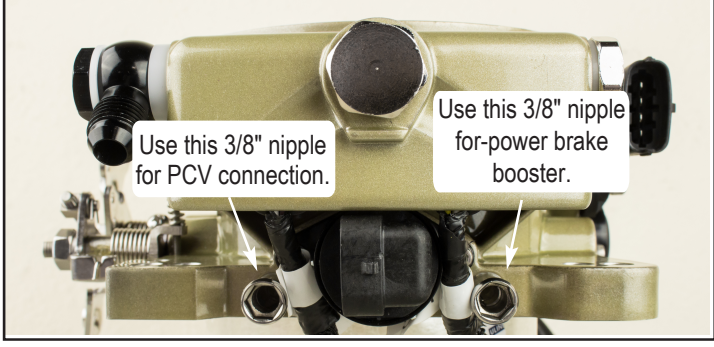

Figure 2

Figure 3



Installing the Throttle Body

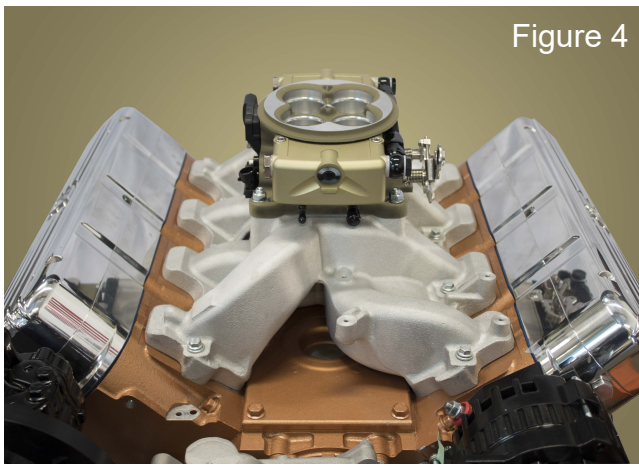

Figure 4

1. Place the supplied gasket on the manifold (see above) and place the throttle body onto the gasket over the existing studs. The throttle body linkage must be on the driver's side of the engine.
2. Install the original nuts and washers onto the four carburetor studs. See Figure 4.
3. Tighten to 10 lb. ft. of torque in several steps using a crisscross pattern.



Figure 5

Installing the Wide Band Oxygen (O₂) Sensor

This is the key component of any EFI system. Only one sensor is required. This sensor continuously monitors the exhaust gas mixture and sends the information to the ECU where adjustments are constantly made to maintain the air/fuel targets.

1. The supplied O₂ Sensor Bung can be installed in either exhaust bank.
2. The Sensor connects to one of the cables in the main wiring harness. See Figure 7 on next page.
3. The ideal location for the sensor is in the exhaust collector or within 8-inches of the collector itself. It must always be at least 18-inches from the exhaust tip, to prevent reversion and false lean conditions.
4. The sensor should be between 10° to 14° above horizontal (see figure 6 below) to allow condensation to run off. If this is not adhered to, the sensor is susceptible to damage.
5. Never position the sensor on the outside of a bend in the exhaust tubing.
6. The sensor must always be mounted ahead of any catalytic converter if vehicle is so equipped.
7. Drill a 7/8" diameter hole in the desired location.

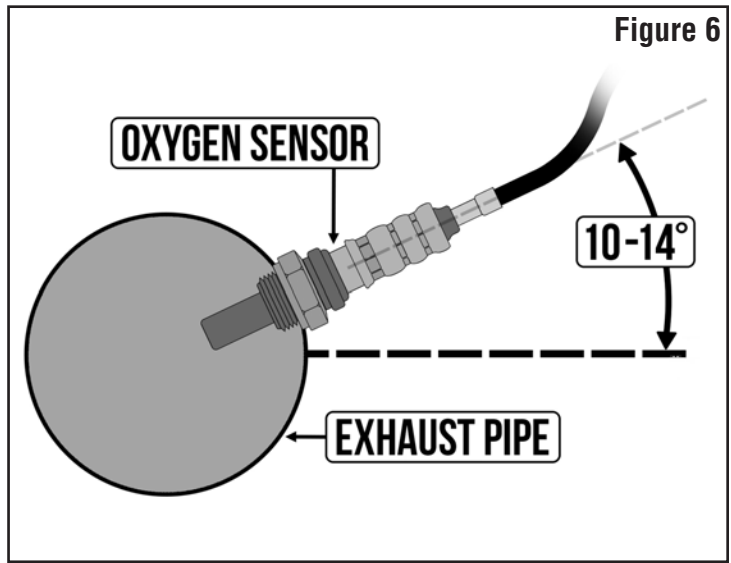

Figure 6

8. The supplied bung kit can either be welded in place or clamped onto the pipe. The clamp-on style works well and will not leak. If welded, make sure the bung is welded completely all the way around and does not leak. Thread an M18-1.5 bolt into the bung to prevent distortion.
9. Install the sensor into the bung. Tighten securely.
10. Connect the O₂ sensor to the sub-harness that connects to the throttle body. See Figure 7.
11. Note: The O₂ Sensor will not work on "Zoomie" style headers.

WARNING: Do not start the engine without the sensor cable connected to the throttle body and the EFI system is fully operational or damage will occur to the sensor!

AIR LEAKS: It is important that no air leaks exist anywhere in the exhaust system, before or after the sensor, as this will cause false readings. This will lead to poor engine performance, including misfires, and the inability to properly auto-tune the EFI. Continued running of the system with an exhaust leak can create detonation and possible severe

engine damage. Incorrect installation of the sensor, exhaust leaks, and any resulting damage is not covered by the FiTech manufacturer's warranty. It is very important to ensure your exhaust is leak-free. For optimum EFI operation and function, your exhaust (on the sensor side) must be totally secure with no leaks.

Installing the Wiring Harness

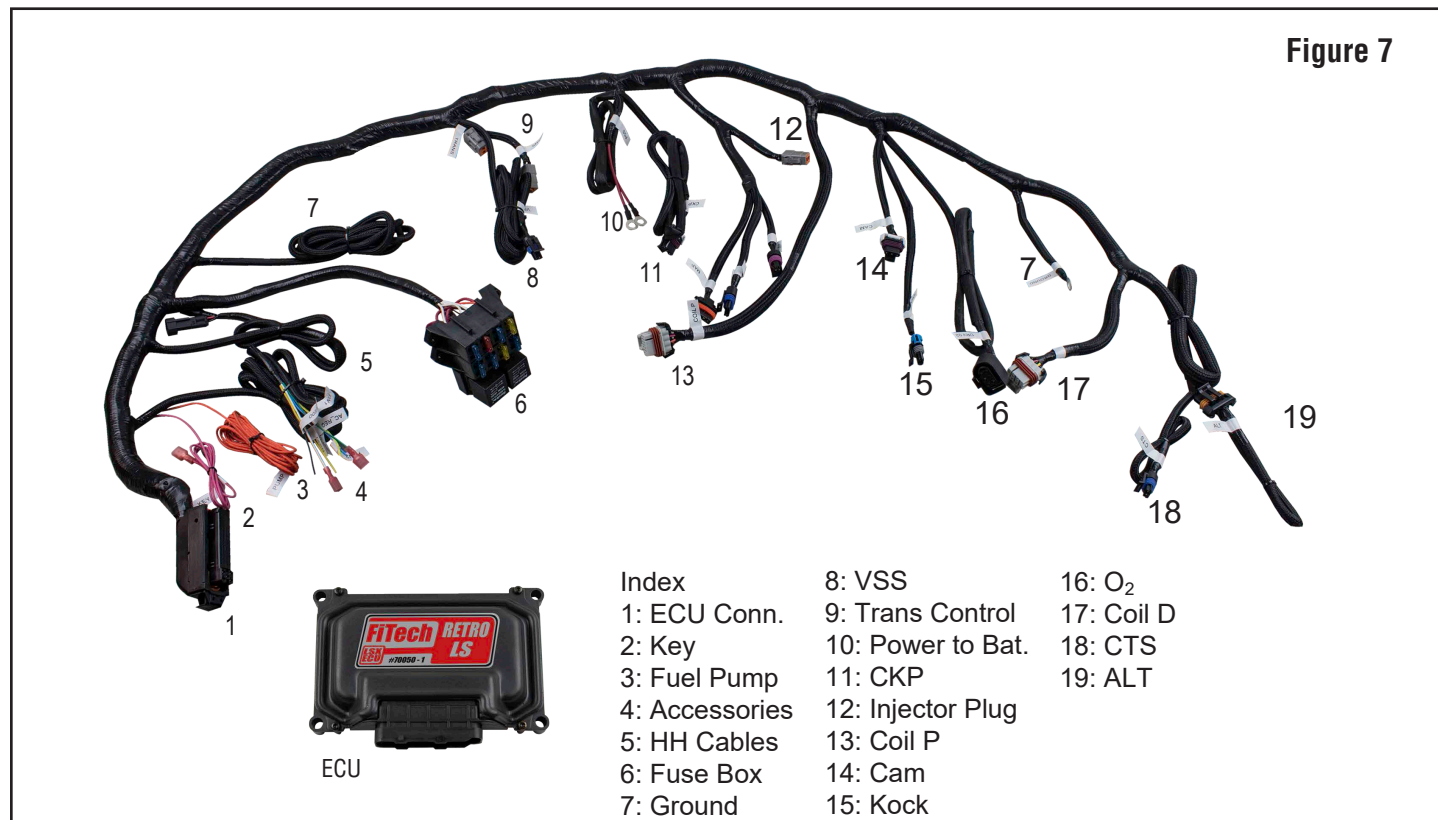

When installing the harness, the external ECU can be mounted anywhere in the engine bay or through the firewall. Be sure to keep it away from excessive heat. The harness is made up of the following connections: MAP, IAC, O₂, TPS, CTS, FAN, CAM, KNOCK, COIL D/P, VSS, TRANS, CKP, ALT, INJECTOR PLUG, GROUND, POSITIVE, ECU, HANDHELD CONTROLLER, FUEL PUMP, and KEY HOT.

MAP (Manifold Absolute Pressure)- Starting with the MAP sensor, the MAP is attached to the outside of the throttle body on the passenger side. It regulates the inlet air temperature and the manifold absolute pressure. The two sensors (inlet air temp and manifold absolute pressure) are combined for ease of installation. The Temperature Manifold Absolute Pressure measures the load on the engine and will range between 10 and 90kPa while the engine is running. When the engine is off it will read at .

99-100kPa. See Figure 8 below.



Figure 8

IAC (Idle Air Control)
The Idle Air Control Sensor gets installed directly into the throttle body. It is used to control the RPM of the motor at idle. See Figure 9, above right.

TPS (Throttle Position Sensor)
The Throttle Position Sensor's purpose is to record how far the

throttle blades are open.

The ECU maintains the calibration of the sensor but, if the TPS reading is not at 0 at idle then the sensor needs to be recalibrated. See Figure 10.

CTS (Coolant Temp Sensor)
The Coolant Temperature Sensor cable plugs into a sensor fitted into driver side cylinder head. It is used to measure the temperature of the engine coolant. The sensor then sends the information to the ECU to adjust fuel. See Figures 17 and 18 on page 6.



Figure 9

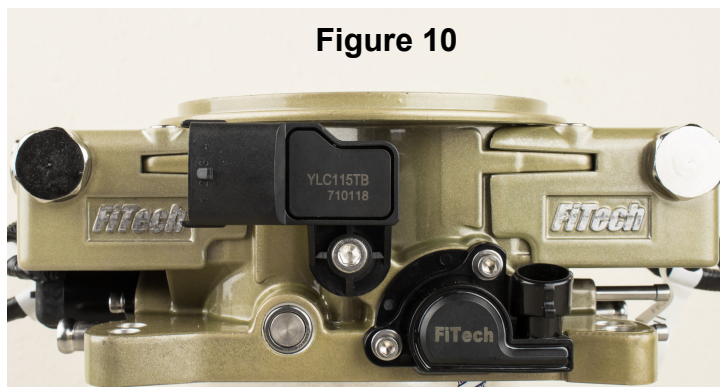

Figure 10

Coil D - Below is the proper way to install the connector labeled "Coil D" to Driver side ignition coils.

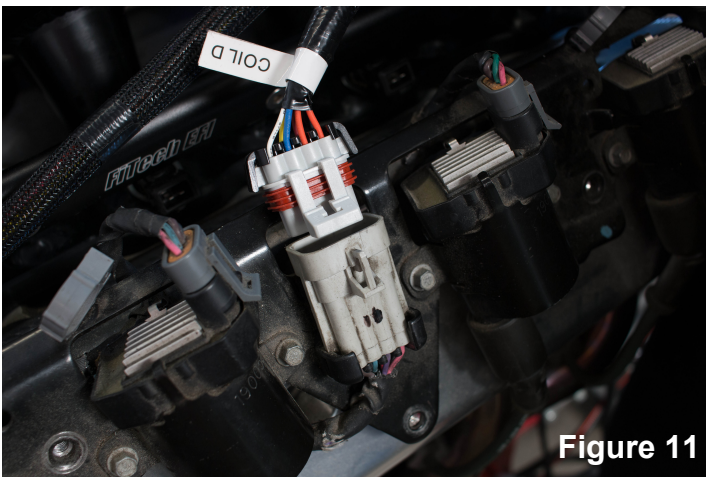

Figure 11

CAM - Install the plug labeled "CAM" on your cam sensor which is located in the rear of the block on LS1 or in front on LS3

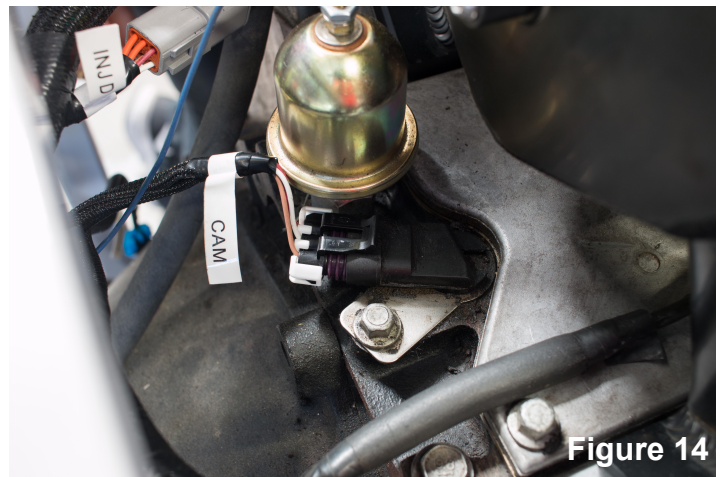

Figure 14

Coil p - Below is the proper way to install the connector labeled "Coil P" to Passenger side ignition coils.

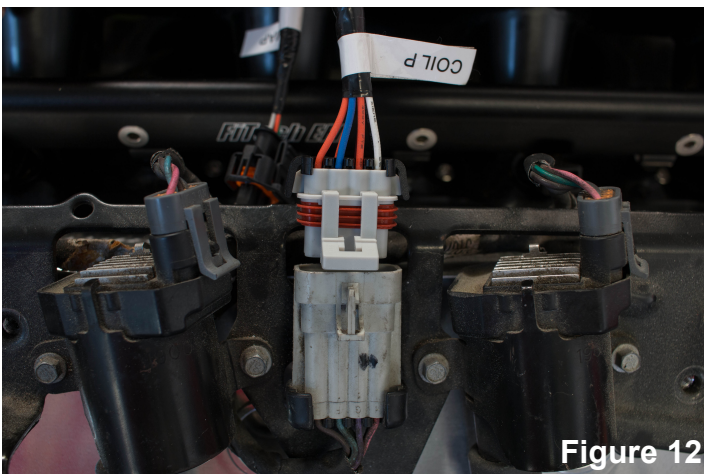

Figure 12

CKP - The connector labeled "CKP" is one of the mos important connectors in the kit, it is also the hardest to find. It is located in the passenger side of the block (if engine is in front of vehicle and the vehicle is RWD) between the starter and the Block.



Figure 15

ALT - Connect the plug labeled "ALT" to your alternator as shown below.

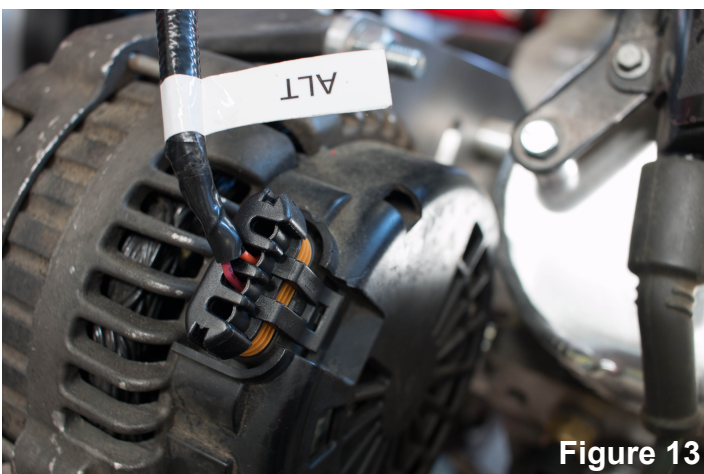

Figure 13

POS - The two red wires labeled "POS" can be easily installed on the starter where there are always 12V present.

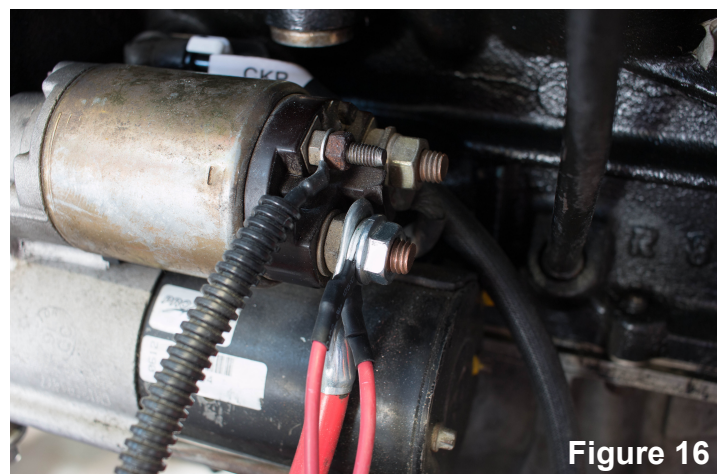

Figure 16



Above - Our CTS plug is made to work with the factory OEM temperature sensor. Replacements are also available if needed.



Above - The CTS connector on the main wiring harness is plugged into the Coolant Temperature Sensor in cylinder head.

Injectors

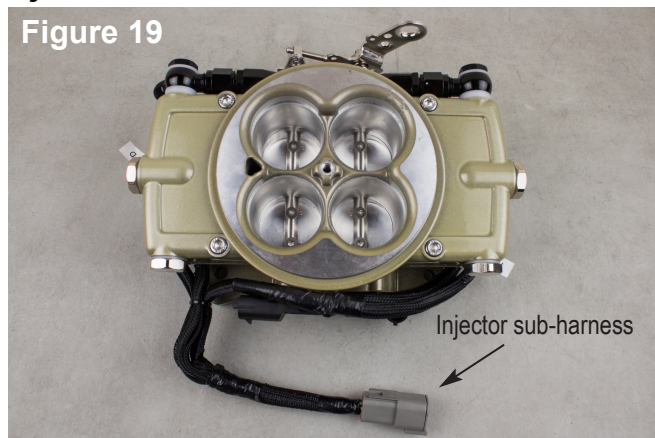

Above - The throttle body has four 80-lb injectors already installed. This arrangement will allow the system to supply enough fuel flow for up to 650 HP. The throttle body has the injector sub-harness preinstalled and ready to go.

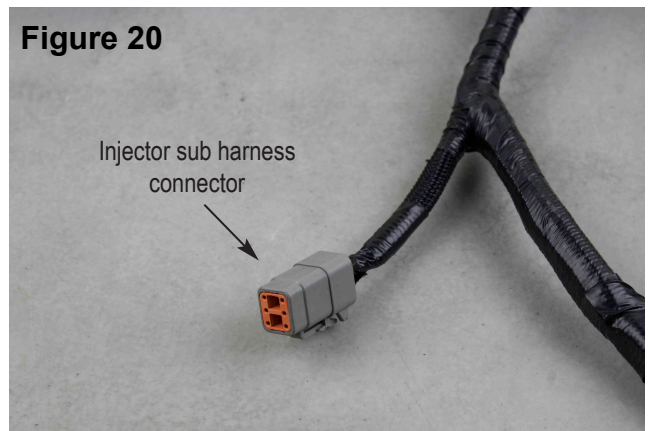

See Figure 7. Connect the injector sub-harness onto the main harness. Make sure the connectors are securely fastened.

Wiring the EFI System

See the wire chart (Figure 21 on page 8 which lists each wire in Harness "A" that is used in the system and what it connects to. NOTE Typically some of the wires listed on the chart on page 8 may need to be extended. It is strongly suggested that any wire extensions are made with the same gauge and color wire as is used in the supplied harness. Make connections as a soldered joint rather than crimped connection. Utilize shrink wrapped sleeve covering all connections.

All modifications made to wiring can only be made on wires listed in Wire Chart Figure 21 on page 8 labeled accessories such as extensions or cuts. **Any modification of the ECU main harness (see Figure 7) other than these listed wires will result in a VOIDING of the FiTech EFI warranty.**

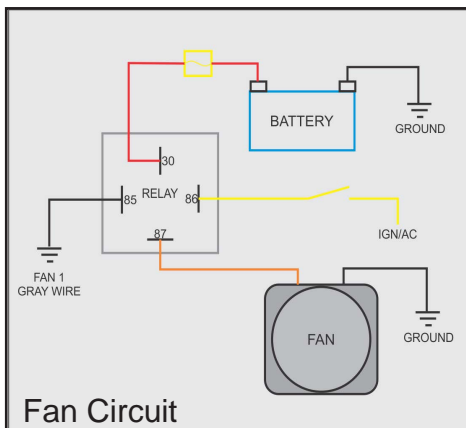

On Engine-Adjustments

When you set idle speed, you will notice some new sounds. The first is ticking from the injectors and it is normal. You may also hear air whooshing or whistling at idle. Barring a vacuum leak, this is likely the bypassed air from the Idle Air Control (IAC valve) and this is normal. The IAC valve maintains idle speed when the AC compressor or electric fans click on.

IAC Setup

The idle screw on the throttle body needs to be adjusted. This needs to be set so that the IAC valve is nearly closed when fully warmed up and in idle 3-10 IAC Steps are recommended for a fully warm engine, out of gear, at idle. When the engine is at idle, the IAC will learn the necessary position to maintain the RPM at the Target Idle Speed. When loads are placed on the engine or when the throttle is open, the IAC steps will move around, this is normal. It's best to adjust this screw from a more open position to start with. This will allow the engine to start at a high idle, which will make adjusting the IAC easier. Follow this procedure:

1. Start the engine and in your Handheld go under "initial set-up."
2. Go to "idle setup" and find "idle set mode" and switch to "Adjust"
3. Start the vehicle and find IAC Steps on the dashboard. This number needs to be within 3-10 at operating temperature. If the number reads zero then slowly turn the screw OUT (counterclock-wise) until the IAC Steps reads between 3-10.

4. If the number is above 10, then turn the screw IN (clockwise) as stated above and repeat the process until the IAC steps are between 3-10.

5. When finished turn key off and allow system to save (30 seconds of key off), and the system will automatically shut off idle set mode

NOTE: Once the IAC set up is complete no further adjustments are necessary

Handheld Controller

There are two ways to navigate the Handheld Controller; you can use the touchscreen with your finger or the joystick: up, down, left, and right. The joystick is the black button on the right hand side of your controller, it can be used to view the displays on the Controller by moving the button up and down or side to side, then pressing the joystick = enter.

1. When making changes to the ECU through the Handheld Controller, make sure that the ignition key is on.

2. Once the changes are made, turn the key off, wait 15 to 20 seconds until the values disappear under the "dashboard" feature. Doing this will ensure that your changes have received a hard save.

3. Once the hard save is completed, if desired, the vehicle battery can be disconnected without interference with the calibrations.

Initial Programming

This simple procedure is performed using the Handheld Controller. A laptop computer is not required.

* This unit plugs into the throttle body ECU

* Input the number of cylinders, cubic inch displacement, cam size, target idle speed warm, fan control, RPM limit and max rev limit.

* The Handheld Controller can be removed or left connected. When connected, there is a "Dashboard" and "Large Gauges" screen that will show engine parameters in real time. Included in your kit is a windshield or dash mounted bracket to hold the controller while driving.

(Note: When changing values on the Handheld Controller, you must depress the joystick button to send your info to the ECU. You will then see 'Sent to ECU Succeed' message which is a confirmation that it was successful (Changing the number alone will not change the value in the ECU). Also, all items have a factory default which may work for you – change only as needed!

1. Cylinders - Factory preset is 8 and shouldn't need to be changed for most installations.

2. Engine CID – Factory preset is 326 CID. To change value you can use touchscreen buttons (Edit, CLR value from screen, Enter your number now, press OK, then depress joystick button to enter). Sent and Succeed message will appear. This entire step can also be performed using the joystick.

3. Cam Mild-Wild – Cam selection is based on vacuum load of the engine. Choose the selection that corresponds with the amount of manifold vacuum your engine produces at idle (in Neutral). Cam 1 is for 15inHg or above, Cam 2 is for 10inHg to 15inHg, Cam 3 is 8inHg to 10inHg, Cam 4 is 6inHg to 8inHg. These are estimates and you may need to switch between them if the vacuum load is between two different cam settings to get the engine to run better for your application.

4. Rev limit RPM – This is a fuel cut. Please set at least 200 RPM above the maximum RPM you wish your engine to run to. This is not a soft touch rev limiter, but a built-in safety feature.

5. Idle Speed Warm – The idle speed at which you wish your engine to run at 150 degrees and above. If you are using the Retro LS Kit to control your electric fans, your idle speed will increase by 30 rpm, will be higher when the engine is colder and will taper down to set speed by 150 degrees.

Fan 1 Setup

On the Calibration screen, follow these steps:

If using an electric fan, go to option # 3 and select Enable , then press Enter or depress the joystick button to send info to the ECU. If not using an electric fan, select Disable and continue the Enter/Send steps above
Note: This step is important to eliminate a fault code from appearing when not using an electric fan, and also eliminating the idle speed from increasing when the fan "ON" temperature is achieved and no fan is used. If fan is enabled, follow these next steps:

#1) Fan 1 ON Temp - Enter desired temperature, Enter/ depress to send to ECU. Idle speed will increase when fan is activated. Idle speed increase is not user programmable in basic calibration.

#2) Fan 1 OFF Temp - This is usually set approximately 5 degrees lower than Fan ON temperature, but is up to user preference. Note: Setting must be lower than fan ON temperature for fans to shut off.

At this point you have made all of the selections you need to start your engine! BUT WAIT!!!!. Please turn your key to the OFF POSITION and wait for about 30 seconds for the ECU to store these changes. This is a one-time setup and the changes are permanently stored in the ECU even if you disconnect the battery! They can be changed at any time in the future but no battery power is needed for the ECU to keep these selections in its memory.

WIRE	location	figure21
1: ECU Connection	This will connect your ecu with the main wiring harness.	
2: Key (Pink)	On/O ff- Connect this wire to a switched 12V circuit. Must be on during both "Key On" and "Cranking"	
3: Fuel Pump (Orange)	Fuel Pump circuit. This wire provides 12V to the fuel pump and connects to the positive terminal on the pump. No relay is required.	
4: Accessories	Dashboard odometers bunch: can be taken out of wire sheathing to be relayed to different places.	
5: HandHeld Cables	Connect the two female ends to the hand-held harness male connectors	
6: Fuse Box	One is pump relay and the other is the main relay.	
7: Ground	2 grounds out ignition and one ground ECU low current.	
8: VSS	Vehicle speed sensor connects to back of the transmission output.	
9: Trans Control	Not used if not using trans control	
10: POS	Main power: positive 12V goes to starter. The circuit needs to be live even when the switch is o ffso that the self-learning files are saved. Uses 25A fuse.	
11: CKP	Crank position sensor, between the block and the starter.	
12: Injector Sub Harness	Connects the main harness with the 4 injector harness pre-installed on the throttle body.	
13: Coil P	Passenger ignition coil pack, coils not in kit.	
14: CAM	Available with extensions for LS3 and LS2 where cam connects to front (Not Included)	
15: Knock	SUB harness extension to reach to LS2 LS3 on side, LS1 on back	
16: O2	Connects to O2 connector	
17: Coil D	Driver ignition coil pack, coils not in kit.	
18: CTS	This wire connects to the engine coolant temperature sensor on the driver side front cylinder head.	
19: ALT	Connects directly to alternator.	
20: TPS	Throttle position sensor: on throttle body.	
21: IAC	Idle air control: on throttle body.	
22: MAP	Manifold Absolute Pressure: on throttle body	

Fuel Delivery Requirements

Note: Before starting any installation, disconnect the ground connection on the battery. Be very careful when disconnecting any fuel lines and let the fuel drain into a receptacle or a dry cloth. Do not allow raw fuel to collect on the engine as this is a fire hazard. Please observe extreme caution when working with the fuel system. The Retro LS Kit is an unregulated system that comes with a fuel crossover hose installed. An external regulator must be used to ensure that the throttle body receives the proper 58psi. When plumbing the Retro LS Kit run a fuel line from the tank through your fuel delivery system then to the crossover hose (-6AN) . (See Figure 22 on next page) If you are using a regulated fuel delivery system then an external regulator is not necessary. If the fuel delivery system does not have a regulator, an external regulator must be installed after the filter.

The Retro LS Kit is not compatible with a low pressure carbureted style pump, it requires a high pressure fuel injection pump available in our Inline Kits, Force Fuel Applications, In-Tank Retro-Fit Kits an in our new Tank and Pump Systems. It is also important to make sure that the system uses a 10 micron filter.

Special Instructions

- We recommend using the **Force Fuel** and **Go Fuel** In-tank Retrofit Kit setup for all installations. A submerged pump is quieter and lasts longer.
- If using the Frame Mount Inline Fuel Pump, it should be mounted at or below the bottom level of the fuel tank and as close to the tank as possible, no more than three feet away from the tank. This type of pump is designed to pump, not draw, and works best when gravity fed.
- Only use hard fuel lines when using proper EFI rated flared fittings.
- Do not use solid core ignition wires
- Make sure that you remove ALL low pressure flex joints on factory fuel lines and replace them with EFI rated fuel hose and use proper flared connections and clamps. Be careful not to mix 45° and 37° AN fittings, they look similar but will not work together. 45° fittings usually come from a hardware store or auto parts store while 37° AN fittings that are supplied by FiTech and most speed shops.
- Inline fuel pump return line must be $\frac{3}{8}$
- Only the steady state fuel “learns”. Cranking and hard throttle hits will not learn, but they can be tuned in Go-EFI Tuning. Selecting the right “cam” and engine CID (cubic inch) will get the learning closer. The Accel Pump will often need tuning for your particular engine combination.
- Your system will be running at 58 PSI so consult an FiTech approved professional if you are not certain about this portion of your installation.
- FiTech does not recommend aluminum fuel lines EVER! Use the supplied EFI high pressure fuel hose supplied in your Fuel Delivery Kit.
- Use the supplied push lock style hose ends only with the supplied hose and vice versa. Interchanging hose ends and hose with other brands could cause leaks
- The Retro LS systems are intended for use with unleaded pump gas up to 15% ethanol content.
- Tach output driver for most tachometer (5V).
- Ensure the engine has had sufficient time to cool before starting!
- It is recommended to use unleaded fuel to ensure a longer lasting oxygen sensor. Leaded fuel will lead to improper exhaust gas oxygen readings. before starting the install ensure the RTV silicone sealer is sensor compatible. This information can be found on the RTV package.
- Ensure to disconnect the negative terminal of the battery before beginning.

Very important note: Your fuel tank must have a vent to prevent pressure building up inside the tank

Figure 22

